

R

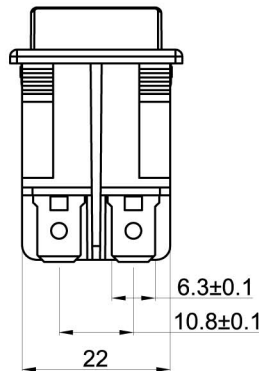

Rating: 20A 125V AC (UL CUL )  
 22A 250V AC (ENEC CB CQC)  
 Contact Resistance: 50m Ω Max  
 Insulation Resistance: DC 500V 100M Ω Min.  
 Dielectric Strength: AC1500V 1 minute  
 Operating Force: 350±150gf  
 Mechanical Life: Over 30,000 cycles  
 Electrical Life: Over 10,000 cycles  
 Operating Temperature: 0°C~85°C  
 Safety Approval:

CUT-OUT

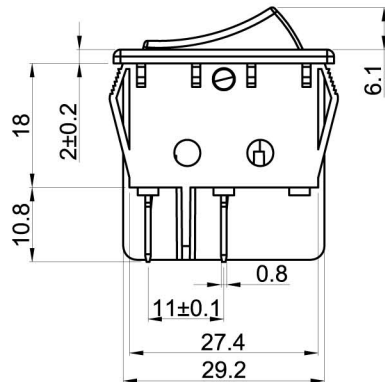
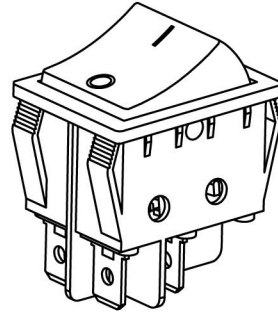
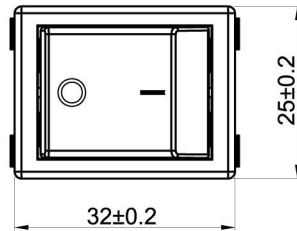
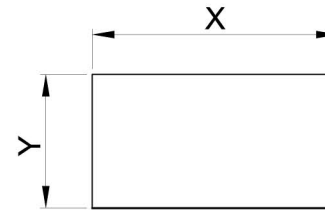

	X	Y
0.75~1.25	30.0+0.1	122.0+0.1
1.25~2.00	30.2+0.1	122.0+0.1
2.00~3.00	30.4+0.1	122.0+0.1

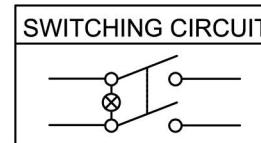

R-210-C5L-BG-220  
 01.086.0135

MATERIAL:

Body:Nylon66,UL rated:94V-2 min.  
 Actuator:PC  
 Terminal:Brass,silver or tin plated